

Article number: 12754000080100

Description: KLEE-coil 754 000 080.100
M8 Steel

Measures

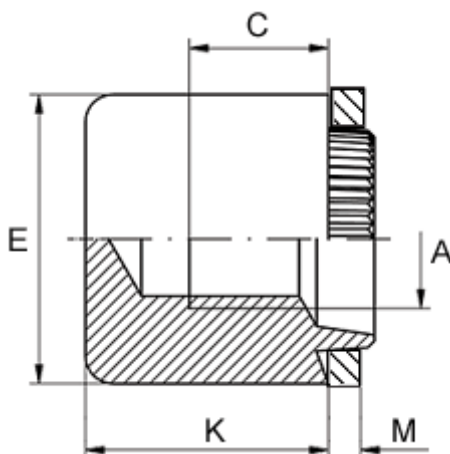

Female thread A	= M8
Height K	= 12.0
Min thread length C	= 6.0
Outer diameter E	= 16.0
Plate thickness	= 3.8 to 4.0
Recommended bore diameter for extreme load	= 13.0
Recommended bore diameter for normal use	= 13.0